



*Power Supply*

Cyber  II

- User Manual
- Benutzerhandbuch
- Manuel d'utilisateur
- Manuale dell'Utente
- Manual del Usuario
- 取扱説明書
- 使用説明書
- 使用说明书
- Руководство для пользователя
- Podręcznik użytkownika
- 사용자 매뉴얼
- คู่มือการใช้งาน
- فارسی
- Kullanım kılavuzu

Follow ENERMAX on social media for the latest information and show us your build with hashtag #ENERMAX

**Facebook:** <https://www.facebook.com/OfficialENERMAX>

**Instagram:** <https://www.instagram.com/OfficialENERMAX>

**Twitter:** <https://twitter.com/OfficialENERMAX>

**YouTube:** <https://www.youtube.com/@OfficialENERMAX>



# INDEX

• Product Notice	1
• Enermax Warranty TR	2
• Component List	3
• Product Introduction	4
• Installation-Cable	6
• Installation-PSU	10
• Specification	11
• Protection	12
• FAQ	12
• 安全注意事項	13
• 限用物質含有情況標示聲明書	15

# Product Notice

Only a technician, authorized by ENERMAX, is allowed to perform maintenance service! Warranty is subject to void under unauthorized attempt to open the power case or modification of any kinds, even attempted only, of the power supply or its components!

**ENERMAX will not be responsible for damages caused by following situations:**

- Opening of the PSU case and/or modification of any component or cable without ENERMAX written authorization.
- Ignoring connector's wrong insertion prevention design by attaching a connector to a device in wrong orientation.
- Connecting too many devices to one cable unit by using additional adaptor (Y cables) .
- The serial number label or warranty seal is defaced, modified, or removed.
- Damage caused by natural phenomena or uncontrollable forces, such as lightning, flooding, fire, earthquake, etc.

 Main plug is used as the disconnect device, the disconnect device shall remain ready for operating.

 Apparatus shall be connected to a MAIINS socket outlet with a protective earthing connection.

This ENERMAX Technology Corporation product is warranted to be free from defects in material and workmanship for a period of five (5) years from the date of purchase. The warranty length may be different in diverse regions based on local policy. ENERMAX Technology Corporation agrees to repair or replace the product, at its own option and at no charge, if, during the warranty period, it is returned to nearest ENERMAX Technology Corporation subsidiary/agent with all shipping charges prepaid and bearing a return merchandize authorization (RMA) number, and if inspection reveals that the product is defective. Charges for removing or installing the product are excluded under the terms of this warranty agreement. This warranty shall not apply to any product, which has been subject to connection to a faulty power source, alteration, negligence, or accident, or to any product, which has been installed other than in accordance with these instructions. In no event shall ENERMAX Technology Corporation, or its subsidiaries, or agents be liable for damages for a breach of warranty in an amount exceeding the purchase price of this product!

We would like to thank you for your support. Please visit our website at:

Global :

Website : <http://www.enermax.com/en>

E-mail : [enermax@enermax.com.tw](mailto:enermax@enermax.com.tw)

Taoyuan :

Website : <http://www.enermax.com>

E-mail : [support-tw@enermax.com.tw](mailto:support-tw@enermax.com.tw)

Germany:

Website : <http://www.enermax.de>

E-mail : [support@enermax.de](mailto:support@enermax.de)

Korea :

Website : <http://enermaxkorea.com>

E-mail : [enermax@cynex.co.kr](mailto:enermax@cynex.co.kr)

TEL : (02)719-2580, 080-719-2581 FAX : (02) 6713-2654

If you have any questions or problems with our products, please contact our support team at [www.enermax.com/support](http://www.enermax.com/support)



# Component List

**A** PSU x 1

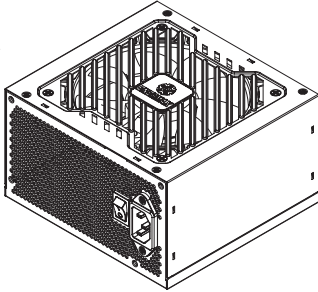

**B** Motherboard 24 pin x 1

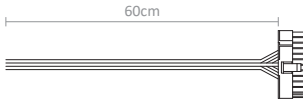

**C** CPU 4+4 pin x 2 (1000W)



**D** CPU 4+4 pin (2 connectors) x 1 (650/750/850W)

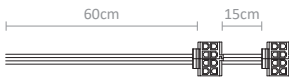

**E** 12V-2x6 12+4 pin x 1 (750/850/1000W)



**F** PCIe 6+2 pin x 1 (1000W)



**G** PCIe 6+2 pin (2 connectors) x 1

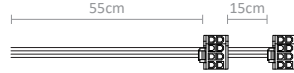

**H** SATA (3 connectors) + 4P Molex (1 connector) x 1 (750/850W) x 3 (1000W)

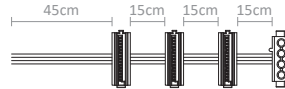

**I** SATA (2 connectors) + 4P Molex (2 connectors) x 1 (750/850W)

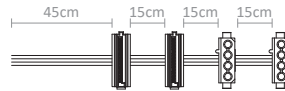

**J** SATA (2 connectors) + 4P Molex (1 connector) x 2 (650W)

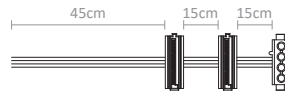

**K** Mounting Screws x 4



**L** AC Cord x 1

\*The actual AC cord depends on different area.

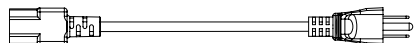

# Product Introduction

\*The actual product depends on different regions or countries.

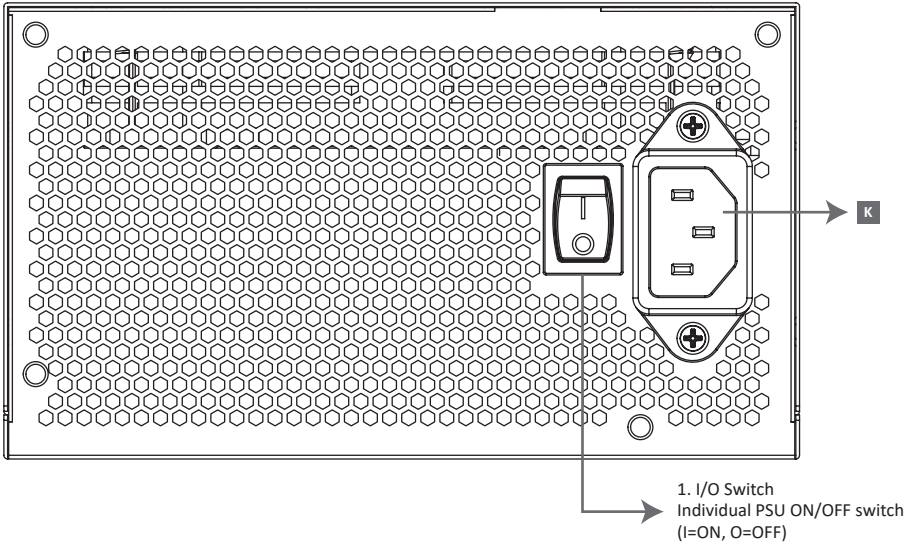

<b><u>DE</u></b>	1. I/O Schalter	Separater Netzteil An/Aus-Schalter (I=AN, O=AUS)
<b><u>FR</u></b>	1. Bouton I/O	(I= ON, O=OFF)
<b><u>IT</u></b>	1. Interruttore I/O	Interruttore di accensione / spegnimento PSU (I=ON,O=OFF)
<b><u>ES</u></b>	1. I/O interruptor	Separado interruptor de la fuente por En/Paro (I=En, O=Paro)
<b><u>JP</u></b>	1. I/Oスイッチ	電源I/O (オン/オフ) スイッチ (I=ON, O=OFF)
<b><u>TW</u></b>	1. I/O開關	電源供應器獨立開關(I=開, O=關)
<b><u>CN</u></b>	1. I/O开关	电源供应器独立开关(I=开, O=关)
<b><u>RU</u></b>	1. Выключатель	отдельный выключатель БП (I=Вкл., O=Выкл.)
<b><u>PL</u></b>	1. I/O Switch	Przełącznik Włączenie/Wyłączenie (I=Włączenie, O=Wyłączenie)
<b><u>KR</u></b>	1. I/O스위치	PSU On/Off 스위치 (I=ON, O=OFF)
<b><u>TH</u></b>	1. สวิตช์เปิด/ปิด	(I=เปิด, O=ปิด)
<b><u>FA</u></b>		کلید روشن/خاموش
<b><u>TR</u></b>	1. I/O Anahtarı	Özgün PSU Açma/Kapama Anahtarı (I: Açık, O: Kapalı)

1. کلید روشن/خاموش

# Product Introduction

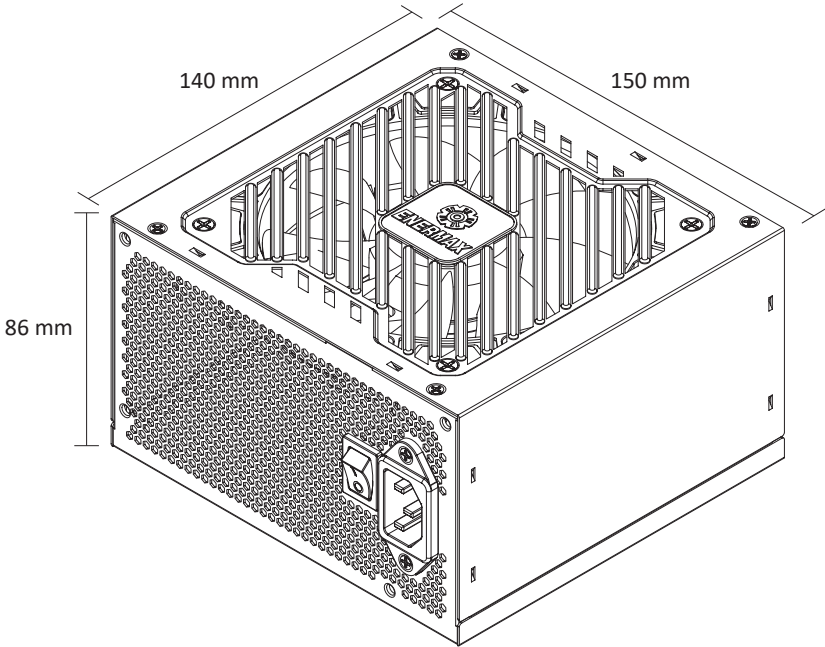

# Installation-Cable

## Motherboard 24 pin

Connect the 24-pin motherboard power.

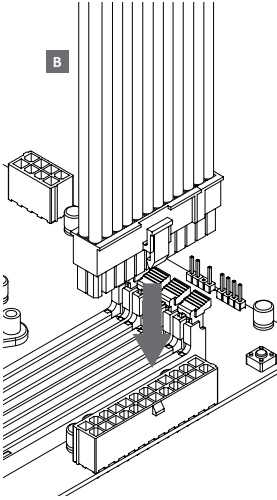

- DE** Schließen Sie den 24-poligen Motherboard-Stromanschluss an.
- FR** Branchez le câble d'alimentation 24 broches de la carte-mère.
- IT** Collega l'alimentazione della scheda madre a 24 pin.
- ES** Conecta la alimentación de la placa base de 24 pines.
- JP** 24ピンのマザーボード電源を接続してください。
- TW** 連接24 pin 主板電源。
- CN** 连接24 pin 主板电源。
- RU** Подключите 24-контактное питание материнской платы.
- PL** Podłącz zasilanie płyty głównej 24-pin.
- KR** 24핀 마더보드 전원을 연결하세요.
- TH** เชื่อมต่อสายเมนบอร์ด 24 พิน
- FA** مادربرد 24 تغذیه منبع کردن متصل
- TR** Anakarta 24-pin kablosunu takınız.

## CPU 4+4 pin

Connect the 4+4 pin CPU power.

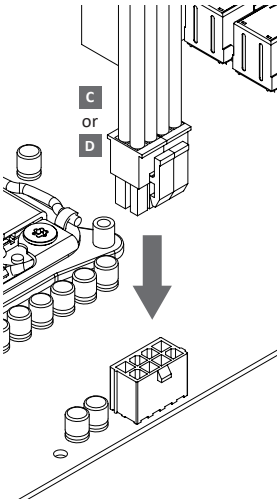

- DE** Schließen Sie den 4+4-poligen CPU-Stromanschluss an.
- FR** Branchez le câble d'alimentation 4+4 broches pour processeur.
- IT** Collega l'alimentazione CPU a 4+4 pin.
- ES** Conecta la alimentación de la CPU de 4+4 pines.
- JP** 4+4ピンのCPU電源を接続してください。
- TW** 連接4+4 pin CPU 電源。
- CN** 连接4+4 pin CPU 电源。
- RU** Подключите 4+4-контактное питание процессора.
- PL** Podłącz zasilanie procesora 4+4 pin.
- KR** 4+4핀 CPU 전원을 연결하세요.
- TH** เชื่อมต่อสาย CPU 4+4 พิน
- FA** بین 4+4 یو پی سی نیروی کردن متصل
- TR** İşlemci için 4+4 pin güç kablosunu takınız.

# Installation-Cable

## 12V-2x6 12+4 pin

Connect the 12+4 pin connector to your GPU as required.

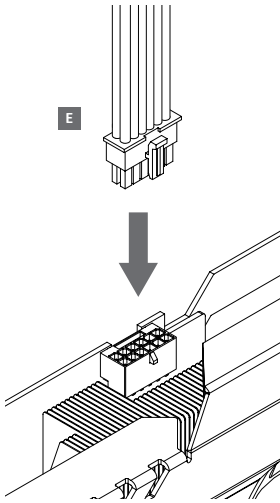

- DE** Schließen Sie den 12+4-poligen Anschluss nach Bedarf an Ihre GPU an.
- FR** Branchez le câble d'alimentation 12+4 broches à votre carte graphique si nécessaire.
- IT** Collega il connettore a 12+4 pin alla tua GPU secondo le necessità.
- ES** Conecta el conector de 12+4 pines a tu GPU según sea necesario.
- JP** 必要に応じて、12+4ピンのコネクタをGPUに接続してください。
- TW** 根據您的需求，將12+4 pin接頭連接至顯卡。
- CN** 根据您的需求，将12+4 pin接头连接至显卡。
- RU** Подключите 12+4-контактный разъем к вашему GPU по мере необходимости.
- PL** Podłącz złącze 12+4 pin do karty graficznej według potrzeb.
- KR** 필요에 따라 12+4핀 커넥터를 GPU에 연결하세요.
- TH** เชื่อมต่อ 12+4 พินกับ GPU
- FA** شما GPU به 12+4 کانکتور اتصال، نیاز صورت در
- TR** Ekran kartı için 12+4 pin güç kablosunu takınız.  
(Eğer ekran kartınız destekliyorsa)

## PCIe 6+2 pin

Connect the PCIe connectors to your GPU as required .

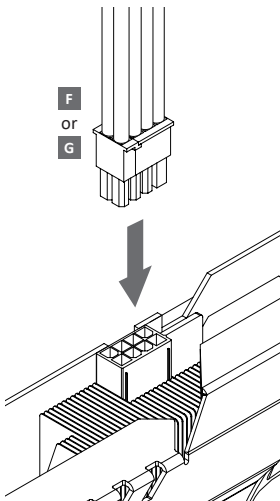

- DE** Schließen Sie die PCIe-Anschlüsse nach Bedarf an Ihre GPU an.
- FR** Branchez les connecteurs PCI-Express à votre carte graphique si nécessaire.
- IT** Collega i connettori PCIe alla tua GPU secondo le necessità.
- ES** Conecta los conectores PCIe a tu GPU según sea necesario.
- JP** 必要に応じて、PCIeコネクタをGPUに接続してください。
- TW** 根據您的需求，將PCIe接頭連接至顯卡。
- CN** 根据您的需求，将PCIe接头连接至显卡。
- RU** Подключите разъемы PCIe к вашему GPU по мере необходимости.
- PL** Podłącz złącza PCIe do karty graficznej według potrzeb.
- KR** 필요에 따라 PCIe 커넥터를 GPU에 연결하세요.
- TH** เชื่อมต่อ PCIe กับ GPU
- FA** شما GPU به PCIe کانکتور های اتصال، نیاز صورت در
- TR** Ekran kartı için 6+2 pin güç kablosunu takınız.

# Installation-Cable

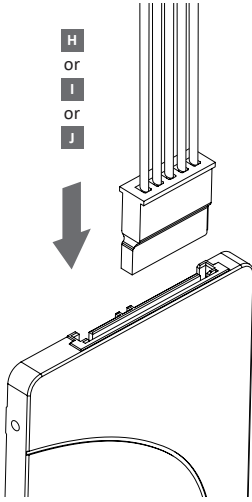

## SATA

Connect the SATA as needed.

- DE** Schließen Sie das SATA bei Bedarf an.
- FR** Branchez le SATA suivant vos besoins.
- IT** Collega l'SATA secondo necessità.
- ES** Conecta el SATA según sea necesario.
- JP** 必要に応じてSATAを接続してください。
- TW** 根據您的需求，連接SATA接頭。
- CN** 根据您的需求，连接SATA接头。
- RU** Подключите SATA по мере необходимости.
- PL** Podłącz SATA w razie potrzeby.
- KR** 필요에 따라 SATA를 연결하세요.
- TH** เชื่อมต่อสาย SATA
- FA** نیاز صورت در SATA اتصال
- TR** Gerekliyse SATA güç kablosunu takınız.

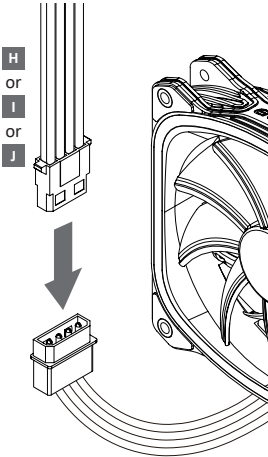

## 4P Molex

Connect the 4P molex to your fans as required.

- DE** Schließen Sie den 4-poligen Molex-Anschluss nach Bedarf an Ihre Lüfter an.
- FR** Branchez le câble molex 4 broches à vos ventilateurs suivant vos besoins.
- IT** Collega il molex a 4 pin ai tuoi ventole secondo necessità.
- ES** Conecta el molex de 4P a tus ventiladores según sea necesario.
- JP** 必要に応じて、4Pモレックスをファンに接続してください。
- TW** 根據您的需求，將4 P molex連接至風扇。
- CN** 根据您的需求，将4 P molex连接至风扇。
- RU** Подключите 4-контактный разъем Molex к вентиляторам по мере необходимости.
- PL** Podłącz złącze 4P molex do wentylatorów według potrzeb.
- KR** 필요에 따라 4P 모렉스를 팬에 연결하세요.
- TH** เชื่อมต่อ Molex 4P กับพัดลม
- FA** شماهای فن به مولکس 4P اتصال، نیاز صورت در
- TR** Gerekliyse kasa fanları için 4P Molex kablosunu takınız.

# Installation-Cable

## Warning

Please only use the modular cables provided in your ENERMAX power supply package. Do NOT use other cables to prevent pin configuration damage to your system and your power supply.

**DE** Bitte verwenden Sie ausschließlich die modularen Kabel, die diesem Netzteil beiliegen. Andere modulare Kabel haben gegebenenfalls eine abweichende Pinbelegung und können Ihr System und Netzteil beschädigen.

**FR** Utilisez uniquement les câbles modulaires fournis dans l'emballage de votre alimentation Enermax. N'utilisez jamais d'autres câbles modulaires et ce, afin d'éviter d'abîmer les broches ou endommager votre système et votre alimentation.

**IT** Si prega di utilizzare solo i cavi modulari forniti nella confezione dell'alimentatore ENERMAX. NON utilizzare altri cavi modulari per evitare danni al vostro sistema e al vostro alimentatore a causa della diversa configurazione dei pin.

**ES** Se ruega utilizar únicamente los cables modulares que están en el embalaje de la fuente de alimentación ENERMAX. NO utilice otros cables modulares para evitar daños al sistema y a su fuente de alimentación a causa de la diferente configuración de los pines.

**JP** 付属されている正規の ENERMAX モジュールケーブルだけを使用して下さい。それ以外のケーブルは互換性がない可能性があり、電源ユニットやシステムへの損傷をもたらす恐れがあるため使用しないで下さい。

**TW** 請依您的ENERMAX電源供應器包裝隨附的模組線材搭配使用。切勿使用標準配件包之外的模組線材，防止損壞您的系統和電源供應器。

**CN** 请依您的ENERMAX电源供应器包装随附的模块线材搭配使用。切勿使用标准配件包之外的模块线材，防止损坏您的系统和电源供应器。

**RU** Пожалуйста, используйте модульные кабели которые прилагаются к вашему блоку питания ENERMAX. Не используйте другие модульные кабели для предотвращения повреждений вашего компьютера и блока питания.

**PL** Proszę używać wyłącznie kable modularne, które zostały dostarczone z tym zasilaczem, aby zapobiec uszkodzeniu systemu i zasilacza przez odmienne kolejności pinów.

**KR** ENERMAX 에서 제공 하는 모듈케이블만 사용 하십시오.  
핀의 형태가 다른 제품을 사용 하시면 사용 중인 시스템 이나 파워스플라이에 치명적 문제가 발생 할 수 있습니다.  
추가적인 모듈케이블이 필요하시면 고객센터로 연락 하시기 바랍니다.

**TH** กรุณาใช้สายเคเบิลที่ให้มาภายในกล่องอุปกรณ์จ่ายไฟของ Enermax เท่านั้น. อย่าใช้สายเคเบิลอื่นๆ กับอุปกรณ์จ่ายไฟของเรา เพื่อป้องกันความเสียหายที่อาจจะเกิดขึ้นได้กับอุปกรณ์และระบบของท่าน.

**FA** فقط مطالعه بفرمایید و مطابق دستورات آن عمل نمایید

**TR** Lütfen yalnızca Enermax kutu içeriğindeki modüler kabloları kullanınız. Başka bir kablo kullanmayınız, sisteminize ve güç kaynağınıza zarar verebilirsiniz.

# Installation-PSU

## Step 1

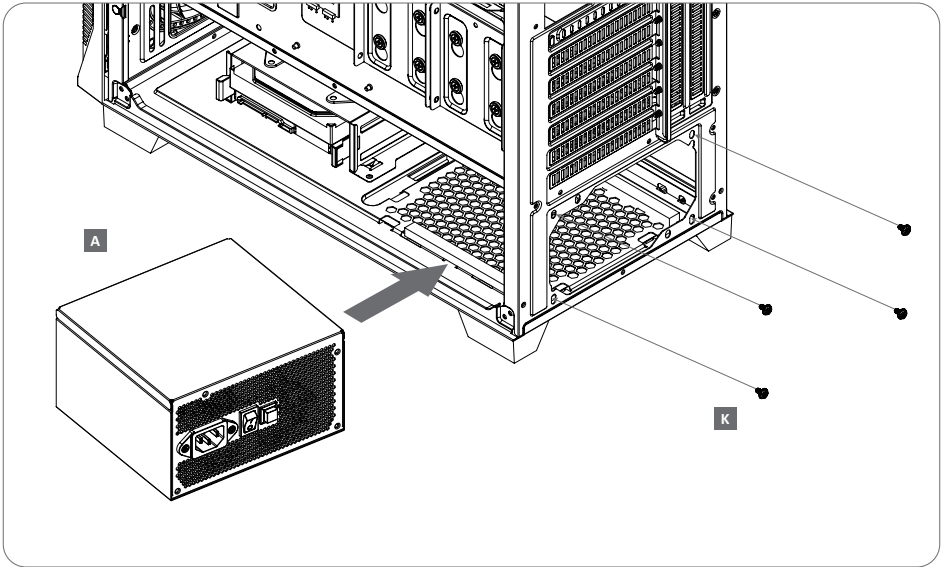

## Step 2

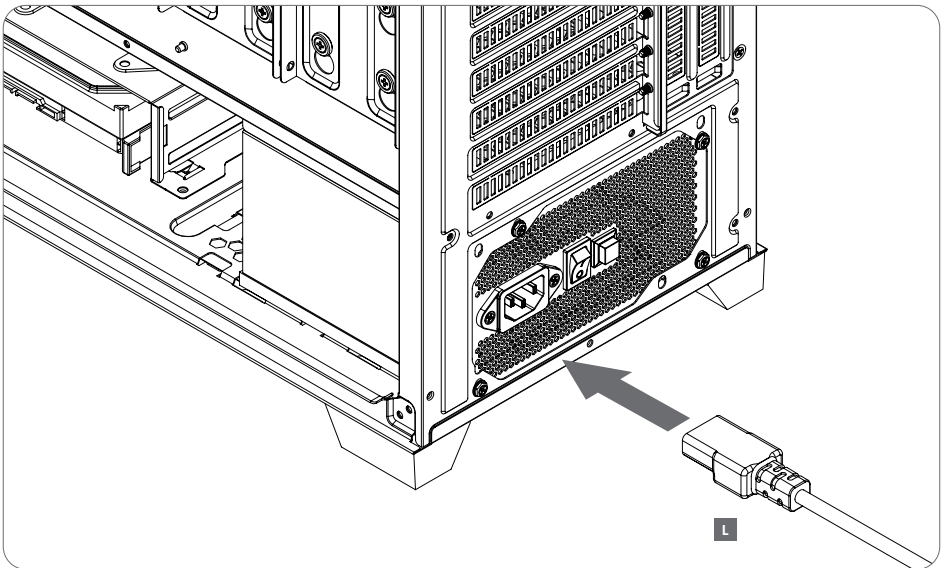

# Specification

Model Spec.	650W		750W		850W		1000W	
AC Input Voltage	100-240VAC, 50-60Hz						100-240VAC, 50-60Hz 200-240VAC, 50-60Hz(for China only)	
AC Input Current	10-6A						15-8A 8A(for China only)	
<b>DC Output</b>								
	Rated	Combined	Rated	Combined	Rated	Combined	Rated	Combined
+3.3V	20A	100W	20A	100W	20A	100W	20A	100W
+5V	20A		20A		20A		20A	
+12V	54.1A	649.2W	62.4A	748.8W	70.8A	849.6W	83.3A	999.6W
-12V	0.4A	4.8W	0.4A	4.8W	0.4A	4.8W	0.4A	4.8W
+5Vsb	2.5A	12.5W	2.5A	12.5W	2.5A	12.5W	3.0A	15W
Total Power	650W		750W		850W		1000W	
<b>Environment</b>								
Temp.	Operating : 0°C to +40°C Non-operating : -40°C to +70°C							
Humidity	Operating : 20% to 85% relative humidity (non-condensing). Non-operating : 5% to 95% relative humidity (non-condensing).							
<b>Others</b>								
Power Factor	PF > 0.95 at full load							
Cooling	One 12cm Sleeve-Bearing Fan							
MTBF	100K hours minimum							
Dimension	150(W)*86(H)*140(D) mm							

# Protection

OCP (Over Current Protection)	OCP makes sure that the output of the DC voltage rails remains within safe operating limits.
OVP (Over Voltage Protection)	OVP shuts down the PSU when the DC outputs exceed a certain level, which is determined by the PSU manufacturer.
UVP (Under Voltage Protection)	UVP shuts off the PSU when the voltage under the certain stander.
OPP (Over Power Protection)	OPP shuts off the PSU when the power drawn is between 130% ~ 170% of the rated power.
OTP (Over Temperature Protection)	OTP makes sure that the PSU will shut down when the internal temperature reaches a set point.
SCP (Short Circuit Protection)	SCP makes sure that the PSU shuts down when the 3.3V, 5V, and 12V rails short to any other rail, or to ground. It also ensures that no damage should occur to the unit, or your PC's components in the event of a short.

## FAQ

**1. Can't find out the 4 pin CPU cable.**

We provide 4+4 pin CPU cables, it can be used in split mode.

**2. How to connect 8 pin PCIe with 6+2 pin PCIe cable?**

Combine the 6 pin and 2 pin before connecting it to the GPU.

**3. How to connect the motherboard cable?**

Plug in the 18 pin and 10 pin connectors to the PSU, and insert the 24 pin connector to the motherboard.

**4. Can't power up the PSU successfully.**

Check if the motherboard and CPU cables are connected to the motherboard exactly, or the PSU will not work.

**5. After installing a new GPU, the PC system crashes frequently.**

It means the PSU is inadequate for your GPU, before purchasing the PSU, please refer to our PSU calculator tool on ENERMAX website.

# 安全注意事項

請您務必遵循產品安全及操作說明中的指示進行操作，請務必留意產品上及操作說明中的所有警告訊息。  
此產品使用於限制區域，為避免人身傷害、電擊、火災或損壞您的裝置，請遵守以下注意事項：

## 1. 一般注意事項：

- 留意修理標識：除說明文件中有特別說明外，請勿自行修理本產品，打開或拆下標有標識  $\triangle$  的產品外殼將可能有觸電的危險。這類元件的內部元件若需修理，應由授權服務供應商完成。
- 需修理的損壞類型：如有下列情形之一，請先從電源插座中拔下電源線，並與授權服務供應商聯絡修理事宜：
  - 電源線、延長線或插頭損壞
  - 液體滲入產品或將異物掉進產品內
  - 產品被雨淋或浸入水中
  - 產品掉落或損壞
  - 過熱的警示訊息
  - 當遵循操作說明進行時，仍無法正常作業
- 避開高溫區：應將產品放置在遠離熱源的地方，如：散熱器、暖氣機、火爐或其他會產生高溫的產品(包括放大器)。
- 避開潮濕區：切勿將產品置於潮濕環境中使用。
- 避免將異物塞入產品：切勿將異物塞入產品的機殼槽口或其他任何開口處，槽口和開口處專為機體散熱和通風而設計，切勿堵塞或掩蓋。
- 安裝附屬裝置：請勿將產品放置在不穩固的平臺上、貨車、講臺、腳架或之架上，安裝任何附屬裝置均應均需按照製造廠商的指示進行，且僅可使用製造廠商所建議安裝的附屬裝置。
- 避免在兒童會出現的地方使用

## 2. 電源線及附屬裝置的安全注意事項：

- 使用正確的外部電源：產品使用的電源類型必須與該產品額定電源標籤上標明的電源類型一致，如果您不知道應使用何種類型電源，請向授權服務供應處或您當地的電力公司查詢，如果產品使用的是電池或其他電源，請參考隨產品附帶的操作說明。
- 選擇正確的電壓：若有提供電壓選擇開關請確保電壓選擇開關已設在您使用的正確電壓類型位置(115VAC或230VAC)。
- 使用認可的電源線：如果您的電腦未配備電源線，請購買當地國所認可使用的電源線。電源線必須符合該產品及其額定電源標籤上所標明的額定電流及電壓要求，電源線的額定電壓、電流應大於產品標籤上標明的額定值。此外電源線直徑的最小規格是0.75公釐d.2/18AWG，長度應介於4到6.5英尺(1.2-2公尺)之間，如果您對應使用的電纜類型尚有疑問，請與授權服務供應商聯絡。
- 仔細佈置電源線：應將電源線佈置在不易被踩壓的地方，請勿在電纜上放置任何物品，以免電源線被擠壓，尤其應注意保護好電源插頭、插座以及電線與電腦的連介面。
- 超負載：請勿在電源插座、配電盤或便利插座上連接太多的電具而使其超負荷運作，整個系統的負載值不應超過該線路額定值得80%，如果使用配電盤，負載值不應超過配電盤輸入額定值得80%。
- 注意延長線的額定值：如果您是使用延長線會配電盤，請確保延長線及配電盤符合產品的額定標準，連接到延長線或配電盤上的所有產品的額定電流(安培)總和不應超過此延長線或配電盤的額定電流(安培)值限制的80%。

## 3. 正確使用電源線及連接線：

- 將電源線插入一個方便您隨時插拔的接地電源插座中。
- 請勿讓電源線上的接地插頭失效，接地型插頭設計是一項重要的安全保護功能。
- 需要切斷電腦的電源時，請將電源線從插座中拔出。
- 從插座拔下電纜時，切勿直接拖拉電纜及連接線。請用手握住電纜插頭，再從插座中拔出。

# 安全注意事項

4.請勿使用電器用電壓轉換器:切勿嘗試使用電器配用的電壓轉換器為電腦提供電源。

5.清潔:清潔前請先從牆上插座中拔下產品的電源線。請勿使用液體清潔劑或氣體清潔劑擦洗。請使用濕布擦拭產品。

6.最大操作環境溫度:40°C。

7.電源容許誤差:+10%,-10%。

8.組裝時的安全注意事項:

- 輸出+12V帶有危險能量，組裝前必須先確認電源是否完全斷離，否則會有被電擊的危險。
- 此產品外殼帶有風扇與電器插接器為外露部份，並符合電氣與防火殼要求，其餘外殼部份均不可外露，且週遭需提供外殼防護不可有任何開孔，否則會有被電擊或起火的危險。

## 電源供應器安裝外殼使用說明:

為了保護使用者及防火的目的，安裝此電源供應器時，必須安裝於符合下列各項要求的外殼中，並且安裝妥善後，才可接上電源。

- 外殼材質須為金屬或鋁製外殼
- 外殼的上方及側邊之圓形開孔，最大內徑不可大於5mm
- 外殼的上方及側邊之長條型開孔，對角線距離不可大於5mm；若寬度小於1mm，則長度不受限制外殼底部不可有開孔
- 外殼底部不可有開孔

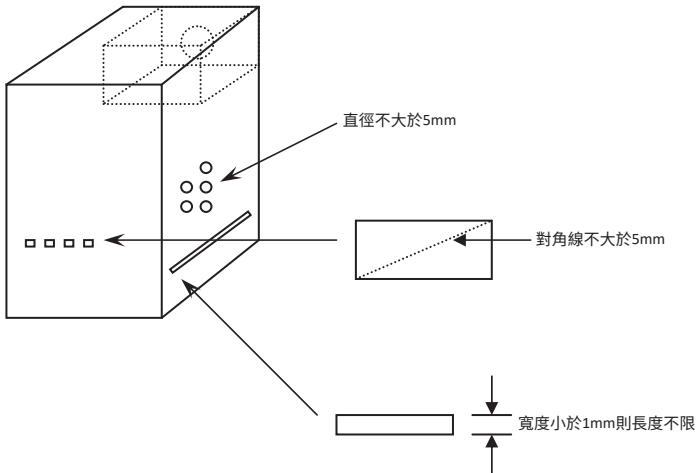

# 限用物質含有情況標示聲明書

Declaration of the Presence Condition of the Restricted Substances Marking

單元 Unit	限用物質及其化學符號 Restricted substances and its chemical symbols					
	鉛 Lead (Pb)	汞 Mercury (Hg)	鎘 Cadmium (Cd)	六價鉻 Hexavalent chromium (Cr <sup>6+</sup> )	多溴聯苯 Polybrominated biphenyls (PBB)	多溴二苯醚 Polybrominated diphenyl ethers (PBDE)
外殼 case	-	o	o	o	o	o
線材 wire	-	o	o	o	o	o
主電路板 The main circuit board	o	o	o	o	o	o
電阻 Resistor	o	o	o	o	o	o
電容 Capacitance	o	o	o	o	o	o
二極體 Diode	-	o	o	o	o	o
貼片二極體 SMD DIODE	-	o	o	o	o	o
集成電路 IC	-	o	o	o	o	o
變壓器/線圈 Transformer /coil	o	o	o	o	o	o
保險絲 FUSE	o	o	o	o	o	o
散熱片 Heat sinks	o	o	o	o	o	o
麥拉絕緣片 Mylar insulation slices	o	o	o	o	o	o
AC開關和插座 Switch and socket	o	o	o	o	o	o
風扇 Fan	o	o	o	o	o	o
塑膠零件 Plastic parts	o	o	o	o	o	o
包裝材料 Packaging materials	o	o	o	o	o	o

備考1. “超出0.1 wt %”及“超出0.01 wt %”係指限用物質之百分比含量超出百分比含量基準值。

Note 1: “Exceeding 0.1 wt %” and “exceeding 0.01 wt %” indicate that the percentage content of the restricted substance exceeds the reference percentage value of presence condition.

備考2. “o”係指該項限用物質之百分比含量未超出百分比含量基準值。

Note 2: “o” indicates that the percentage content of the restricted substance does not exceed the percentage of reference value of presence.

備考3. “-”係指該項限用物質為排除項目。

Note 3: The “-” indicates that the restricted substance corresponds to the exemption.





© 2024, ENERMAX Technology Corporation,  
2F-1 , No. 888, Jing-Guo Road, Taoyuan City (330)  
Tel. +886-3-316-1675, Fax. +886-3-346-6640

All rights reserved. Actual product and accessories may differ from Illustrations. Information in this manual is subject to change without prior notice. Printing errors and omissions excepted. All trademarks, registered trademarks and/or product names mentioned are the property of their respective owners.



Oct. 2024